

Online ENGINE

6000 SUBSEA TEMPERATURE & PRESSURE LOGGER OPERATING MANUAL

The 6000SD is a compact, self-contained subsea unit which logs and displays readings from internal digital pressure and temperature sensors to ensure acceptable hydrotest results have been achieved

Online Electronics Ltd
Online House
Blackburn Business Park
Woodburn Road, Blackburn
Aberdeen
AB21 0PS
UK
+44 (0)1224 714 714
www.online-electronics.com
OEL-Sales@ik-worldwide.com

Royal Mechanical Group Pty Ltd
Level 14, 197 St. Georges Tce,
Perth, WA 6000
Australia
+61 (0) 452 506 896
www.royalmechgroup.com
Sales@royalmechgroup.com

ROYAL
OIL & GAS

Collaborate • Innovate • Succeed



An IK Group Company

6000 SERIAL NUMBER:	
SENSOR1 SERIAL NUMBER:	
P1 FULL SCALE RANGE:	
SENSOR2 SERIAL NUMBER:	
P2 FULL SCALE RANGE:	
P1 CALIBRATION CERTIFICATE:	
P2 CALIBRATION CERTIFICATE:	
T1 CALIBRATION CERTIFICATE:	
T2 CALIBRATION CERTIFICATE:	

6000_5001			
Rev	Date	By	Summary of change
A00	09/08/17	BG	CR00485: Was 6000 LOGGER MANUAL RevB06. CR00380 Address change. CR00499 Front Cover update. CR00494: Sensor replacement.
A01	11/10/17	BG	CR00499: Cover page update
A02	01/04/20	TL	CR00881: Email Address and Logo Updated

COMMENTS:

CONTENTS**Page**

1.	GENERAL DESCRIPTION	5
2.	SPECIFICATIONS.....	6
3.	RULES FOR SAFE OPERATION	7
4.	OPERATION	8
4.1.	TURNING ON	8
4.2.	SINGLE BUTTON MENU INTERFACE	8
4.2.1.	EXIT	10
4.2.2.	STATUS	10
4.2.3.	UNLOAD	10
4.2.4.	SET LOG INTERVAL	10
4.2.5.	SHUTDOWN	10
4.2.6.	MORE	10
4.2.7.	LOW POWER ENABLED / DISABLED	10
4.2.8.	DP ENABLED / DISABLED	11
4.2.9.	MEM OVER ENABLED / DISABLED	11
4.2.10.	CONFIGURE ALARM	11
4.2.11.	SENSOR ENABLED / DISABLED	11
4.2.12.	SET SENSOR ADDR	12
4.2.13.	SET TIME	12
4.2.14.	SET DATE	12
4.2.15.	ERASE LOG	12
4.3.	LIMITS DISPLAY	12
4.4.	RAM MEMORY ERROR	13
4.5.	MEMORY FULL	13
4.6.	DATA UNLOAD	14
4.6.1.	LOGGED DATA FORMAT	15
4.6.2.	LOGGING CAPACITY	15
4.7.	BATTERY REMOVAL	16
4.8.	BATTERY LIFETIME	16
4.9.	SOFTWARE INSTALLATION	17
4.9.1.	MICROSOFT .NET FRAMEWORK INSTALLATION	17
4.9.2.	6000 SOFTWARE INSTALLATION	17
4.9.3.	USB-RS485 DRIVER INSTALLATION	17
4.10.	EXTERNAL CONNECTIONS	18
4.11.	CALIBRATION	18
4.12.	SENSOR REPLACEMENT	19
4.13.	ROV SWITCH OPTION	19
4.14.	ACOUSTIC MODEM OPTION	19
5.	DEPLOYMENT CONSIDERATIONS	20
5.1.	MOUNTING	20
6.	MAINTENANCE	21
6.1.	O-RING REPLACEMENT	21
6.2.	SUBSEA CABLES / CONNECTORS	21
6.3.	ROUTINE MAINTENANCE AND STORAGE	22
7.	DISPOSAL OF UNIT	22
8.	WARRANTY	22

1. GENERAL DESCRIPTION

The 6000 Temperature and Pressure Subsea Logger is a compact, self-contained, subsea unit which logs and displays readings from internal digital pressure and temperature sensors. A high visibility OLED display shows the current readings subsea. The user can turn the unit on and off as well as modify all available settings and unload data using a single control button and intuitive menu system.

The 6000 is particularly useful for hydrostatic testing of pipelines. The unit can be configured to display the differential pressure between P1 and P2 thus simplifying consideration of water depth. Features such as the LIMITs display and acoustic transmitter interface mean that a successful test can be confirmed without needing to recover the unit for download of data.

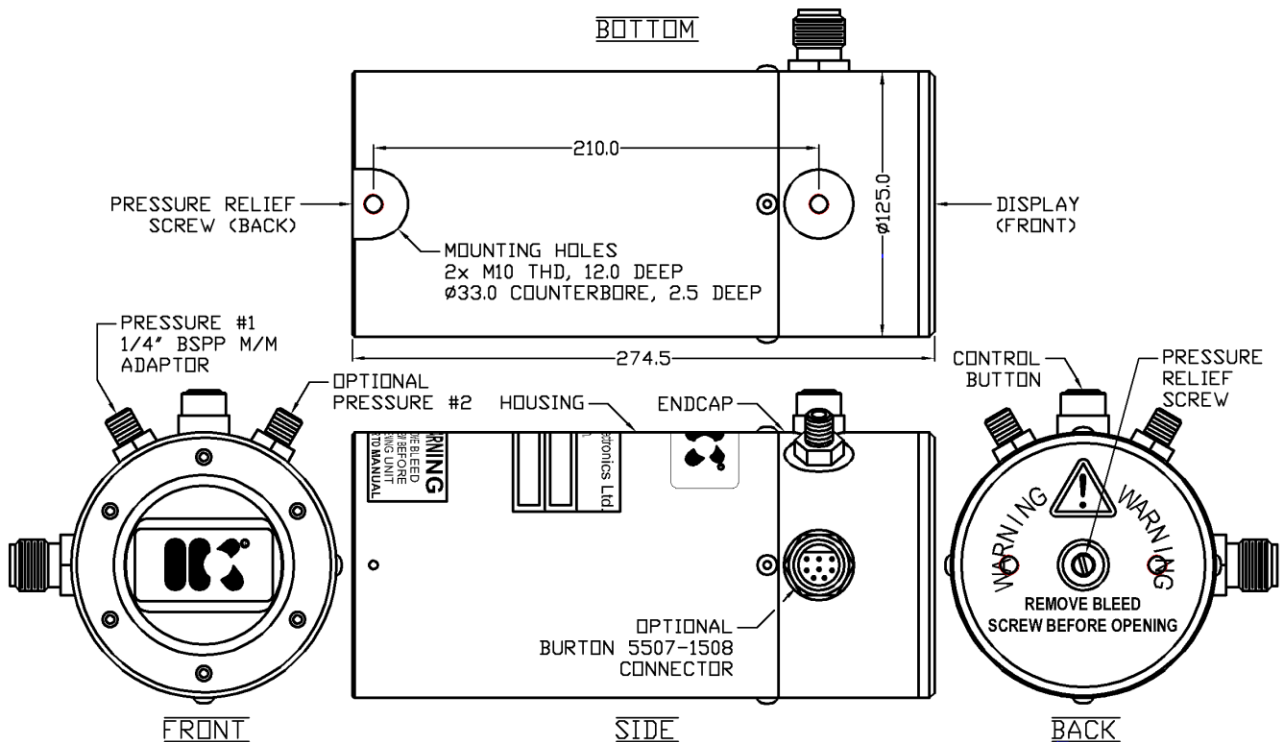

MOUNTING OPTIONS: As standard, the unit is supplied with 2x 12mm deep, M10 threads, 210mm apart as shown above.

ADDITIONAL SENSORS: The unit can be supplied with up to 2x pressure and 2x temperature sensors.

POWER OPTIONS: The unit can be powered from an internal battery OR an external +15V to +28V supply. The standard battery pack is made up from Alkaline cells but the unit can be powered from a Lithium pack if required to provide extended battery life, particularly at temperature extremes.

RS485 OPTION: The user can monitor the sensor readings via an optional RS485 link using dedicated software providing advanced features such as live graphing of readings. Standard terminal software such as HyperTerminal or TeraTerm can be used for basic interfaces.

ACOUSTIC PINGER INTERFACE OPTION: The unit can be interfaced with a standard acoustic pinger to begin pinging, stop pinging, or change rate when a particular pressure, temperature, or time threshold is reached.

ACOUSTIC DATA TRANSDUCER INTERFACE OPTION: The unit can be interfaced with an acoustic data transducer. This allows readings to be monitored every 1 minute at a range of up to 10km.

2. SPECIFICATIONS

Below are the standard specifications for the 6000. Please refer to the table on Page 2 of this manual for the specifications of the 6000 delivered with this manual.

GENERAL

Battery life at 5°C with LOW POWER mode DISABLED	21 days
Battery life at 5°C with LOW POWER mode ENABLED	105 days
Battery type.....	12V Alkaline pack BATT-11213
Operating temperature range	-5°C to +65°C
External pressure rating	300bar
Standard pressure range	0-700 barg (please contact OEL to discuss options)
Standard pressure sensor accuracy	±0.05% FS (0.001 bar resolution)
Pressure connection	¼" BSPP M/M ADAPTOR or Customer specified
Temperature sensor accuracy.....	±0.5°C (0.01°C resolution)
Weight in air	13kg

MATERIALS:

Housing material.....	ALLOY BRONZE CA104 EN 12163
Endcap material.....	ALLOY BRONZE CA104 EN 12163
Bleedscrew material	ALLOY BRONZE CA104 EN 12163
Window material.....	ACRYLIC
Endcap o-rings	2x BS 50-243 NBR70 with 2x BS 250-243 PTFE BURs
Window o-ring.....	1x BS 50-236 NBR70
Bleedscrew o-ring	1x BS 50-008 NBR70

OPTIONS:

External power	+15V to +28V
Data communication.....	RS485
Remote communication	Acoustic data transducer
Additional sensors	Optional second pressure and second temperature
Logging	Various regimes available

3. RULES FOR SAFE OPERATION

⚠ WARNING: Any operation involving pressure is potentially hazardous. No person should use this equipment unless fully aware of the potential hazards of working with pressurised vessels. The purchaser of this equipment is responsible for the training and competence of operators and the manner in which it is used. This manual should be read through and understood before installation and commissioning so that the operator is familiar with the equipment. Contact Online Electronics Ltd immediately should any difficulty arise in the use of this equipment.

⚠ WARNING: ALWAYS loosen the bleedscrew to relieve any internal pressure prior to opening this unit.

⚠ WARNING: Always use caution when opening equipment which has been in a pressurised environment. It is possible for pressure to leak into the equipment and remain there even after external pressure has been removed. ALWAYS point the end to be opened towards a safe area and away from yourself or others. Contact Online Electronic immediately if there is a suspicion that the equipment has become pressurised.

⚠ CAUTION: Opening of the equipment should take place in a clean, dry, laboratory environment.

⚠ CAUTION: To prevent the formation of condensation within the unit, allow the unit temperature to stabilise within the laboratory environment for a minimum of 6 hours prior to opening.

⚠ CAUTION: It is possible for liquids to become trapped in threads and/or gaps around openings. ALWAYS point the end to be opened downwards to allow any trapped liquid to drain out of and not into the equipment.

⚠ CAUTION: Do not expose to aggressive solvents or chemicals which could be harmful to the HOUSING, O-RINGS, CONNECTORS or any other parts of the equipment.

⚠ CAUTION: If the external connector is unused, it MUST be fitted with a suitable blanking connector (e.g. BURTON 5501-1508-0000) to prevent conduction between the pins and malfunction.

⚠ CAUTION: A protective rubber cap is fitted over the control button to prevent ingress of debris. Always ensure that after pressing the control button it returns to the un-pressed position. If required the button can be un-screwed and rinsed in fresh water to clear out any debris.

4. OPERATION

Familiarise yourself with all warnings given at the start of Section 3 RULES FOR SAFE OPERATION.

4.1. TURNING ON

To turn the unit on simply press and hold the control button until the OEL logo is displayed and then release, this takes approximately 5 seconds. Refer to the figure on the following page

The OEL logo will be displayed for 5 seconds as shown by the COUNTDOWN INDICATOR located at the bottom left hand side of the display. A battery level indicator is shown at the bottom right hand side of the display. This meter gives an indication of the remaining battery lifetime while at room temperature. A fresh battery should be fitted before each deployment. This screen can be skipped within 5 seconds by pressing the control button.

The next screen shows the 6000 logo. In between showing this screen and the next screen the unit will carry out a self-check of the RTC circuitry and logger memory. If any potential problems are detected then error messages will be displayed as per section 4.4 RAM MEMORY ERROR and section 4.5 MEMORY FULL.

The next screen is the STATUS screen. This shows the current configuration of several settings. This screen is described in section 4.2.2 STATUS.

After displaying these three screens the unit will begin taking and displaying reading(s) from all enabled sensor(s). The display will show a LOG message to confirm logging at the configured LOG INTERVAL as per section 4.2.4 SET LOG INTERVAL. Every 1 minute the logged data is examined and LIMITS are displayed as per section 4.3 LIMITS DISPLAY.

4.2. SINGLE BUTTON MENU INTERFACE

Refer to the figure on the following page. At any point while the unit is displaying reading(s) the control button can be pressed to enter the menu interface. From the menus the user can view and change several parameters which are discussed in this section.

While in the menu system, every time the user presses the control button the CURSOR will move down one line and the COUNTDOWN INDICATOR will be reset to 5. Once the CURSOR is pointing at the desired item the user simply allows the COUNTDOWN INDICATOR to reach 0 and the selected item will be executed. This simple behaviour is used throughout the menu interface to modify settings and interact with the unit. The menu system is designed so that if the control button is not pressed the unit will always exit and resume taking readings as normal.



PRESS/
TIMEOUT

BATTERY
INDICATOR



PRESS/
TIMEOUT



PRESS/
TIMEOUT



PRESS

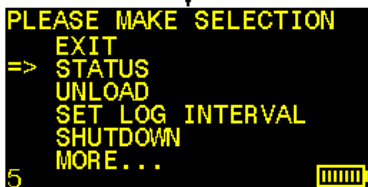

PRESS

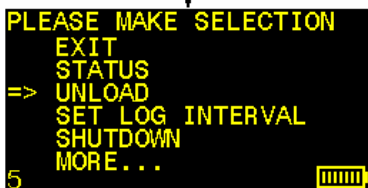

PRESS

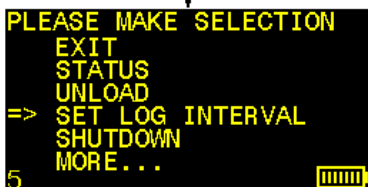

INDICATE LOG

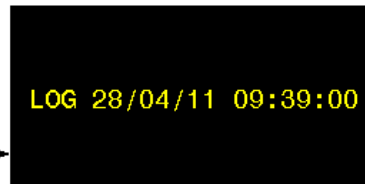

LOG INTERVAL

EVERY 1 MINUTE

SHOW LOGGED LIMITS

P1	148.107	150.458	24 HOUR
P2	818.001	820.583	
T1	05.46	05.67	48 HOUR
T2	05.47	05.66	
P1	148.107	150.798	48 HOUR
P2	818.001	820.583	
T1	05.04	05.67	48 HOUR
T2	05.02	05.66	
	MIN.	MAX.	

MORE...

COUNTDOWN
INDICATOR

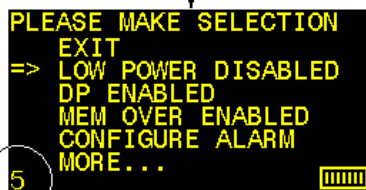

MORE...

CURSOR

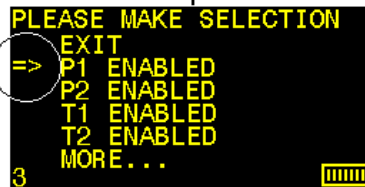

MORE...

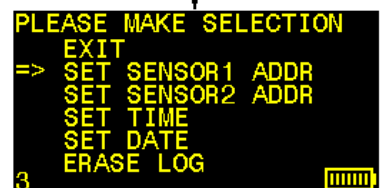

4.2.1. EXIT

Every page of the menu system starts with EXIT. If EXIT is selected the unit will exit the menu system and resume taking and displaying readings from all enabled sensors.

4.2.2. STATUS

The STATUS screen is shown at power-up after the 6000 logo and can also be viewed at any point by selecting STATUS from the menu system. It shows the Date, Time, Firmware type, Firmware version, Log interval, Memory overwrite setting, sensor address settings, and Alarm configuration. The STATUS screen can be paused by pressing and holding the control button for up to 10 seconds. Ensure all of these settings are at the required values.

4.2.3. UNLOAD

Selecting this item causes the unit to unload all logged data via RS485. Refer to section 4.6 DATA UNLOAD for instructions regarding retrieving logged data. Selecting this item does not erase any logged data.

4.2.4. SET LOG INTERVAL

Selecting this item allows the user to change the LOG INTERVAL. The LOG INTERVAL can be set to every 1, 2, 5, or 10 minutes. At each log interval the unit will log 6 columns of data representing Date, Time, Pressure 1, Pressure 2, Temperature 1, and Temperature 2. A message as shown will also appear for approximately 2 seconds. Refer to section 4.5 MEMORY FULL and section 4.6.1 LOGGED DATA FORMAT for more information.

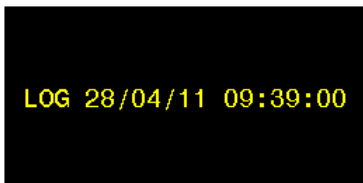

4.2.5. SHUTDOWN

Selecting this item switches the unit OFF. The unit is fitted with non-volatile memory which will remember all settings (LOW POWER mode setting) made via the menu system next time the unit is switched on.

⚠ CAUTION: It is imperative that the unit is turned off using this command rather than simply disconnecting the battery so that any memory storage processes are allowed to terminate prior to turning OFF.

4.2.6. MORE

Selecting this item shows the next page of the menu system. Refer to the figure in section 4.2 SINGLE BUTTON MENU INTERFACE to see the menu pages and items available.

4.2.7. LOW POWER ENABLED / DISABLED

This item shows whether or not LOW POWER mode is ENABLED or DISABLED. If LOW POWER is DISABLED then the display is permanently on and will update readings every 1 second. If LOW POWER is ENABLED then the display turns on for 2 seconds every 15 seconds to show the sensor readings. If the control button is pressed while the display is off and LOW POWER is ENABLED then the display will turn on for 15 seconds. If the control button is pressed while the display is on then the unit will enter the menu interface as normal.

4.2.8. DP ENABLED / DISABLED

This item shows whether or not DP (Differential Pressure, the unsigned differential pressure between P1 and P2) is ENABLED or DISABLED. If DP is ENABLED then the display will replace the reading for T1 with DP. Irrespective of this setting, the logged data will be unchanged; P1, P2, T1, T2 will be logged. Note that the unit does not round readings to the nearest least significant digit so the DP result may include an error of ± the least significant digit.

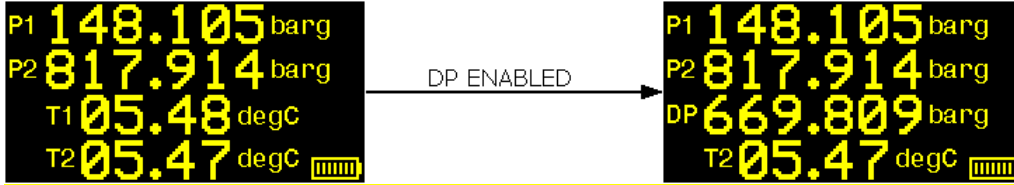

4.2.9. MEM OVER ENABLED / DISABLED

This item shows whether or not MEMORY OVERWRITE is ENABLED or DISABLED. ENABLE MEMORY OVERWRITE to allow the logger to overwrite oldest data first should the logger memory become full. DISABLE MEMORY OVERWRITE to prevent the logger from overwriting old data should the logger memory become full. See section 4.5 MEMORY FULL.

4.2.10. CONFIGURE ALARM

Selecting this item allows the user to configure the alarm interface of the unit. The alarm can be configured in either of two modes: DIFFERENTIAL (a single threshold value is compared against the unsigned difference between P1 and P2) or INDEPENDENT (an alarm threshold for P1 is compared against P1 and a second threshold for P2 is compared against P2). The table below shows the relevant conditions and the resultant output resistance between the GND and ALARM connections (see section 4.10 EXTERNAL CONNECTIONS). Typically a dual rate acoustic transmitter is used as an alarm configured to transmit at a faster rate if the output resistance is >1MΩ or at a slower rate if output resistance is 1kΩ.

MODE	PRESSURE & THRESHOLD	OUTPUT
DIFFERENTIAL	P1 - P2 < THRESH	>1MΩ
DIFFERENTIAL	P2 - P1 < THRESH	>1MΩ
DIFFERENTIAL	P1 - P2 > THRESH	1kΩ
DIFFERENTIAL	P2 - P1 > THRESH	1kΩ
INDEPENDENT	P1 > THRESH1 AND P2 < THRESH2	>1MΩ
INDEPENDENT	P1 < THRESH1 AND P2 > THRESH2	>1MΩ
INDEPENDENT	P1 < THRESH1 AND P2 < THRESH2	>1MΩ
INDEPENDENT	P1 > THRESH1 AND P2 > THRESH2	1kΩ

To disable the alarm on a sensor, disable the sensor using the OLED menu or configure a suitably high threshold. While in DIFFERENTIAL mode both sensors must be enabled.

While in LOW POWER mode is DISABLED the alarm state is checked every 1 second. While LOW POWER mode is ENABLED the alarm state is checked every 15 seconds.

4.2.11. SENSOR ENABLED / DISABLED

These menu items show the status of each sensor and allow the user to ENABLE or DISABLE sensors. As standard the unit is fitted with a single pressure and temperature sensor with address 01. A second pressure and temperature sensor can be fitted and is given the address 02 as standard. If a sensor is disabled then 'D00.000' will be displayed and logged.

4.2.12. SET SENSOR ADDR

As standard the unit is fitted with a single pressure and temperature sensor with address 01. A second pressure and temperature sensor can be fitted and is given the address 02 as standard. Each sensor is clearly marked with its' address inside the unit. This item allows the user to select the correct address if they have a sensor with a non-standard address. Follow the instructions on screen to change the sensor address.

4.2.13. SET TIME

This item allows the user to set the internal time which is logged with each reading. Follow the instructions given on screen to modify this value. While setting the seconds field the control button can be held down to pause the current time to help synchronise with a reference time.

4.2.14. SET DATE

This item allows the user to set the internal date which is logged with each reading. Follow the instructions given on screen to modify this value. Ensure a valid date is used, for example February does not have 31 days.

4.2.15. ERASE LOG

Selecting this item will erase all logged data once the user has been prompted to confirm. Configuration settings remain unchanged. Ensure that any important data has been unloaded and saved before selecting this item.

4.3. LIMITS DISPLAY

Every 1 minute the LIMITS DISPLAY screen will appear for approximately 2 seconds. The screen can be paused (for up to 10 seconds) by pressing and holding the control button.

The top set of readings show the maximum and minimum readings logged within the last 24 hours or since the last LIMITS RESET (if LIMITS RESET occurred within the last 24 hours).

P1	148.107	150.458	} 24 HOUR
P2	818.001	820.583	
T1	05.46	05.67	} 48 HOUR
T2	05.47	05.66	
P1	148.107	150.798	} 48 HOUR
P2	818.001	820.583	
T1	05.04	05.67	} 48 HOUR
T2	05.02	05.66	
	MIN.	MAX.	

The bottom set of readings show the maximum and minimum readings logged within the last 48 hours or since the last LIMITS RESET (if LIMITS RESET occurred within the last 48 hours).

A LIMITS RESET occurs every time the unit is turned ON, the LOG is ERASED, or the LOG INTERVAL is changed.

Note that the LIMITS DISPLAY will not appear until at least one log has occurred since the last LIMITS RESET. This means that if the LOG INTERVAL is configured for 10 minutes then it may take up to 10 minutes for the LIMITS DISPLAY to start appearing every 1 minute.

The LIMITS DISPLAY ignores disabled sensors and sensors returning errors.

4.4. RAM MEMORY ERROR

The unit contains a coin cell (BR2032) used to permanently power the Real Time Clock circuitry which stores the date and time as well as other system variables such as LOW POWER mode while the unit is turned OFF.



At switch ON the unit conducts a self-check on the RTC circuitry as per section 4.1 TURNING ON. If any problems are found then the *RAM MEMORY ERROR* message will be displayed and the unit will reset all system variables to default values. Please contact Online Electronics Ltd if you see this message. The most likely cause is that the coin cell has expired. Refer to Section 6.3 ROUTINE MAINTENANCE AND STORAGE for more information.

Note that if the unit has detected a problem and has reset to default values (shown below) then an UNLOAD will result in the entire logger memory unloading and any blank areas in the memory will contain 'Fs' instead of numerical data.

P1	ENABLED
P2	ENABLED
T1	ENABLED
T2	ENABLED
MEM OVERWRITE	ENABLED
LOW POWER MODE	ENABLED
DP READING	ENABLED
LOG INTERVAL	05 minutes
SENSOR ADDR1	01
SENSOR ADDR2	02
ALARM THRESHOLDS	000.0 bar

4.5. MEMORY FULL

At switch ON the unit conducts a self-check on logger memory as per section 4.1 TURNING ON. If the logger memory is found to be full then the ** MEMORY FULL** will be displayed.



If MEMORY OVERWRITE is DISABLED and the logger memory is FULL then the unit WILL NOT log any new readings and this error message will be shown every time the logger attempts to log.

If logging is required the memory should either be erased as per section 4.2.15 ERASE LOG or MEMORY OVERWRITE should be ENABLED as per section 4.2.9 MEM OVER ENABLED / DISABLED.

4.6. DATA UNLOAD

1. Connect the USB end of the 6000 download cable to the PC and the Burton end of the 6000 download cable to the unit.
2. Referring to the figure below, open the software and select the COM port which the 6000 USB download cable is connected to in the 'Available COM Ports' drop down menu. If the correct COM port number is not known then each available COM port can be tried in turn until the correct one is found or the correct COM port can be identified from the Device Manager within windows (right click on My Computer> Properties> Device Manager).
3. Turn the unit ON by pressing and holding the control button until the ONLINE logo appears on the display.
4. Press the 'Connect' button to connect to the unit. The software will begin receiving readings from the unit and displaying them as text in the 'Data' window. Each time the unit sends data, a green light should flicker on the USB connector. If required the graphs can be enabled at this point by ticking the 'Enable Graphs' checkbox.

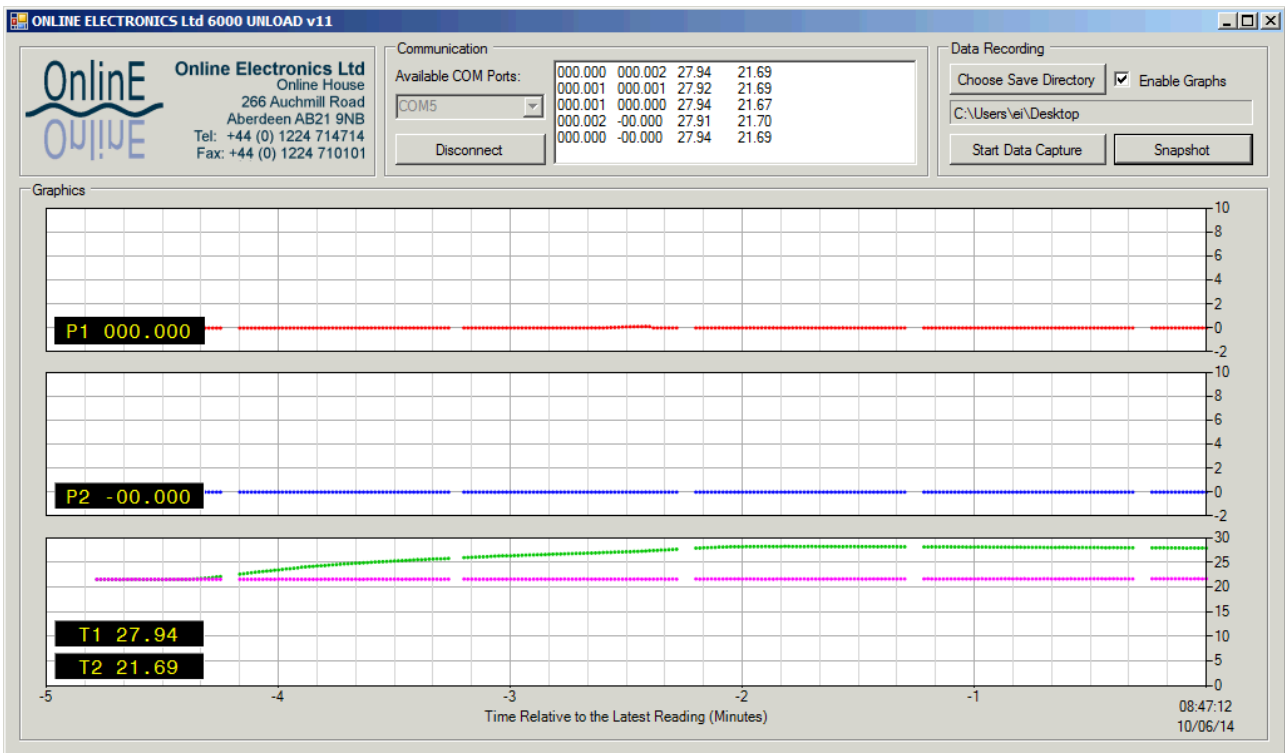

5. Press the 'Choose Save Directory' button to define a location to save any captured data or screen snapshots to. Ensure that the location is somewhere easy to find such as the Desktop. Captured data will be saved with filename '6000 DATA YYMMDD HHMMSS.TXT'. Screen snapshots will be saved with filename '6000 SNAPSHOT YYMMDD HHMMSS.PNG'.
6. Press the 'Start Data Capture' button to start capturing all data coming from the unit to the file '6000 DATA YYMMDD HHMMSS.TXT'.
7. On the unit itself, select UNLOAD from within the display menu. The unit will transmit the word 'START' to the PC, followed by all logged data, followed by the word 'STOP'. While the unit is transmitting this data the unit display and the software 'Data' window will show '...UNLOADING...'. There may be a delay between the unit sending all data and the software receiving all data. Confirm that the software is finished receiving all data by confirming that the '...UNLOADING...' message is no longer displayed in the 'Data' window. To avoid disturbing the process do not use the PC until all logged data has been received.

The transfer process can take up to 15 minutes depending on how much data has been logged.

8. Press the 'Stop Data Capture' button within the software to save the logged data to the '6000 DATA YYMMDD HHMMSS.TXT' file.
9. Open the '6000 DATA YYMMDD HHMMSS.TXT' file and ensure that the required data has been stored. Confirm that the data starts with the word 'START' and finishes with the word 'STOP'. This data can be pasted directly into a spreadsheet for analysis and/or for generating graphs.
10. At this point the data stored in the unit can be erased by selecting the ERASE LOG option within the display menu. This means there will be less data to unload next time.
11. Press the 'Disconnect' button to disconnect from the unit and then exit the software.
12. ALWAYS disconnect the 6000 download cable from the unit when not in use. In particular never leave the download cable connected to the unit while the USB end is not connected to a PC or the PC has been turned off.

4.6.1. LOGGED DATA FORMAT

A single reading is stored in 6 columns representing Date, Time, Pressure 1, Pressure 2, Temperature 1, and Temperature 2 respectively:

```
DD/MM/YY <SP> HH:MM:SS <TB> P1 <TB> P2 <TB> T1 <TB> T2 <CR> <LF>
```

Where <TB>, <SP>, <CR>, and <LF> represent 'Tab', 'Space', 'Carriage Return', and 'Line Feed' characters respectively. This data can be pasted directly into a spreadsheet for analysis and/or for generating graphs. All pressure values are logged in 123.123 format and all temperature values are logged in 12.12 format.

The unit transmits logged data in ASCII format at 115200 baud, 8 Data bits, No parity, 1 Stop bit, and with No Flow control. Any terminal program such as HyperTerminal or TeraTerm configured with these settings can be used to receive the logged data if required.

If an enabled sensor has been disconnected, has the incorrect address, or has malfunctioned then the sensor reading 'E00.000' shall be displayed and logged. Ensure that the sensor is connected and that the address shown on the STATUS screen matches the address marked on the sensor itself.

If a sensor is disabled then the sensor reading 'D00.000' shall be displayed and logged.

Blank areas within the logger memory contain 'Fs' instead of numerical data. See section 4.4 RAM MEMORY ERROR.

4.6.2. LOGGING CAPACITY

The unit is fitted with 2 Mbytes of internal memory available for logging allowing it to store over 130,000 readings. This equates to a logging capacity of over 90 days logging every 1 minute, or over 900 days logging every 10 minutes. If the logging memory becomes full then it automatically wraps around and begins overwriting the oldest data first.

The unit can take a significant amount of time to transmit all logged data depending on how much data has been stored. Unloading the entire memory can take up to 15 minutes and the resultant *.txt file size is typically 5.9MB.

4.7. BATTERY REMOVAL

1. Familiarise yourself with all warnings given at the start of Section 3 RULES FOR SAFE OPERATION.
2. Opening of the unit should only take place in a clean, dry, laboratory environment.
3. To prevent the formation of condensation within the unit allow the unit to stabilise within the laboratory environment for a minimum of 6 hours prior to opening.
4. Loosen the bleedscrew to relieve any internal pressure.
5. Remove the 4x M5 screws around the perimeter of the housing.
6. Carefully remove the housing from the endcap. Ensure that the O-ring seals are protected from damage and contamination while the unit is open.
7. Pull off one side of the rubber battery cover.
8. Confirm the unit is turned OFF before disconnecting the battery pack. Replace the battery pack, ensuring all wires are installed neatly and protected from accidental damage.
9. Examine the O-ring seals for any signs of damage or contamination. Refer to section 6.1 O-RING REPLACEMENT for instructions on replacing the O-rings if required.
10. Reassemble the unit following the above instructions in reverse.
11. Tighten the bleedscrew.

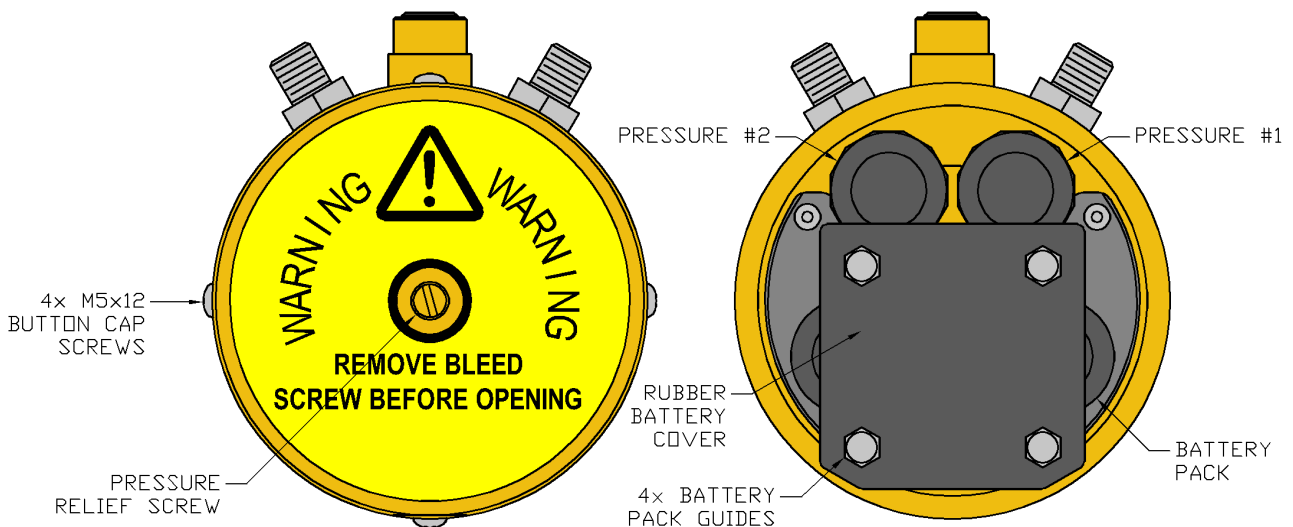

4.8. BATTERY LIFETIME

As with all battery powered equipment the operating temperature which the unit is used at alters the operating lifetime. Typically colder temperatures shorten the lifetime. For the standard Alkaline pack the lifetime at +20°C will typically be 20% more than the lifetime at +5°C. Please contact Online Electronics Ltd for more details or to discuss your requirements.

4.9. SOFTWARE INSTALLATION

There are three stages to the software installation. Instructions for each stage are given below.

4.9.1. MICROSOFT .NET FRAMEWORK INSTALLATION

The software supplied by Online Electronics requires the Microsoft .NET Framework to be installed on the host PC. For more information about the .NET, or to download the latest version, visit www.microsoft.com/net. The latest version can also be found on the software CD supplied by Online Electronics and can be installed by following the instructions below.

1. Log into the host PC as an administrator with full administrator rights.
2. Execute the dotNetFx40_Full_x86_x64.exe file found in the .NET folder on the CD.
3. Follow all instructions provided on screen to complete the installation.

4.9.2. 6000 SOFTWARE INSTALLATION

The unit transmits data in ASCII format at 115200 baud, 8 Data bits, No parity, 1 Stop bit, and with No Flow control. Any terminal program such as HyperTerminal or TeraTerm configured with these settings can be used to receive the logged data.

The 6000 software supplied Online Electronics is basically a simple terminal program which receives ASCII data from a COM or serial port. It also includes some more advanced features such as the ability to log incoming data and generate graphs of live data coming from the unit. To install the dedicated software supplied by Online Electronics follow the instructions below.

1. Log into the host PC as an administrator with full administrator rights.
2. Execute the setup.exe file found in the 6000 UNLOAD folder on the CD.
3. Follow all instructions provided on screen to complete the installation.
4. The software will now be available in the Start menu.

4.9.3. USB-RS485 DRIVER INSTALLATION

The 6000 download cable includes a USB to RS485 converter which requires VCP (Virtual COM Port) drivers to be installed on the host PC. For more information, or to download the latest version, visit www.ftdichip.com/FTDrivers.htm. The latest driver version can be found on the software CD supplied by Online Electronics and can be installed by following the instructions below.

1. Log onto the host PC as an administrator with full administrator rights.
2. Connect the USB to an available USB port on the host PC. If windows does not already have suitable drivers installed it will automatically detect the device and prepare to install drivers.
3. When prompted to, point windows towards the RS485 DRIVERS folder on the CD.
4. Follow all instructions provided on screen to complete the installation.

4.10. EXTERNAL CONNECTIONS

⚠ WARNING: Attaching external power without having the unit reconfigured WILL result in permanent damage. The unit can be configured for use with an internal battery pack OR external power, NEVER both. This configuration MUST be carried out at Online Electronic premises or by OEL trained personnel.

If fitted with a Burton 5507-1508, 8 way bulkhead connector to provide connection to external power, communications, and other interfaces the standard connections will be as shown below.

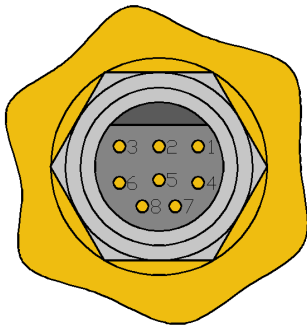

BURTON 5507-1508 BCR MATING FACE

SIGNAL	BURTON CONNECTION
GND	1
MODEM	2
NO CONNECTION	3
RS485A(-)	4
SWITCH	5
RS485B(+)	6
NO CONNECTION	7
ALARM	8

4.11. CALIBRATION

The accuracy of the sensors can be checked at any point by applying a known reference pressure or temperature to the sensors and recording the reading returned by the unit. The sensors must be removed from the unit and returned to Online Electronics for recalibration. Online Electronics can supply replacement calibrated sensors which can be fitted to the unit in the field. Calibration of the unit itself is not required.

STANDARD PRESSURE SENSORS

Typically the 6000 is fitted with 700 barg sensors which are calibrated at 0, 175, 350, 525, and 700 bar to be within ±0.35 bar at each point (0.05%FS). Refer to the table on Page 2 of this manual for details of the sensors fitted to the 6000 unit supplied with this manual.

Contact Online Electronics Ltd for more information regarding additional sensor options.

STANDARD TEMPERATURE SENSORS

As standard the unit is fitted with temperature sensors which are calibrated at 3x points: +0°C, +15°C, and +30°C at atmospheric pressure. The sensors are adjusted to be within ±0.2°C at each point. Application of significant pressure can alter the temperature reading, total temperature error is ±0.5°C from +0°C to +30°C.

4.12. SENSOR REPLACEMENT

1. Following the instructions described in Section 4.7 BATTERY REMOVAL open the unit.
2. The sensors are then visible and accessible as shown in the image from Section 4.7 BATTERY REMOVAL.
3. Unscrew the plastic end from each sensor to expose the electrical connection.
4. Carefully pull out the electrical connection.
5. Use a 27mm spanner to unscrew each sensor.
6. Each new sensor should be clearly marked with an address 01, 02, 03 or 04. The 6000 can be reconfigured to point the relevant address to the required P1/T1 or P2/T2 as per Section 4.2.12 SET SENSOR ADDR of this manual.
7. Make sure that the sensor Orings and 6000 sealing faces are undamaged, lightly greased and free from dirt etc.
8. Screw in the new sensors.
9. Refit the electrical connection carefully noting that there is a small tab to indicate correct orientation. It does not matter which electrical connection goes to which sensor since the sensors are addressed on an RS485 BUS.
10. Refit the plastic end to each sensor which provides strain relief.
11. Temporarily switch the unit on, reconfigure sensor addressed if required as per Section 4.2.12 SET SENSOR ADDR and confirm that valid readings are received.
12. Reassemble the unit following the instructions as detailed in Section 4.7 BATTERY REMOVAL.
13. Temporarily switch the unit on again to reconfirm function.

4.13. ROV SWITCH OPTION

The ROV switch behaves in an identical way to the manual control button. The unit is always fitted with a control button. When fitted with an ROV switch, either the control button or the ROV switch can be used to control the unit.

The ROV switch is a robust, rotary switch which can be rotated indefinitely in either direction. The switch contact closes when in the ON position (see figure below) and will open after turning the switch approximately 45° in either direction. When not in use the ROV switch should be rotated 180° away from the ON position to prevent accidental activation, it may also be fixed in this position with a plastic tie wrap using the 'locking' hole provided.

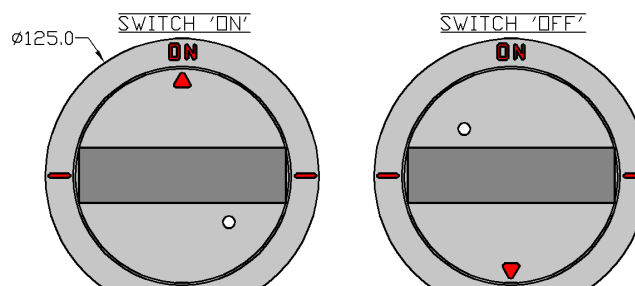

4.14. ACOUSTIC MODEM OPTION

The unit can be interfaced with the OEL 1200 series, acoustic pinger data modem. In the standard configuration (every 1 minute) the unit will transmit a 6 digit number using the pinger modem representing the current P1 reading in millibar (for example, the number 031345 represents 31.345 barg).

Using the OEL 2001RS acoustic receiver, this acoustic signal can be monitored at a ranges of up to 10km depending on the condition of the acoustic path. Refer to the 1200 and 2001RS system manuals for more information.

The 1200 series pingers also have the functionality of a regular dual rate acoustic alarm so background ping rates (in addition to the modem data) can be configured so that if a pre-defined pressure threshold is crossed the pinger will immediately change background ping rate.

5. DEPLOYMENT CONSIDERATIONS

The following section does not provide a comprehensive deployment procedure as every deployment is different; however it does outline the most important considerations when deploying the 6000 and should be read and understood well in advance of deployment.

At least 24 hours prior to deployment any personnel who will be involved with the operation of the 6000 should review this entire manual to familiarise themselves with the unit. They should also be allowed time to operate the unit on deck. Simply allowing personnel to 'play' with the unit before it is actually deployed can save significant costs compared to deploying the unit without understanding how it works and then suffering from an unnecessary operator error.

OEL recommend fitting a new battery pack before each deployment to ensure longest possible lifetime should the job be unexpectedly extended.

Turn the unit on and confirm that it is configured as required and functioning. Check that the unit is logging data and the data can be unloaded successfully.

Ensure that any unused connectors are suitably blanked to prevent conduction between pins and malfunction when submerged in saltwater. Refer to Section 3 RULES FOR SAFE OPERATION for further information on blanking plug requirements.

5.1. MOUNTING

The two main options for mounting are described and illustrated in the Figure below.

STRAP MOUNTED – The 6000 is provided with a Delrin mounting plate which allows ratchet straps or banding to be used to clamp the unit onto a pipeline or other infrastructure.

DEPLOYMENT CRADLE – The 6000 is provided on a custom cradle manufactured to customer specifications. This cradle may include additional equipment such as the ROV switch, flashing strobe, acoustic transmitter etc.

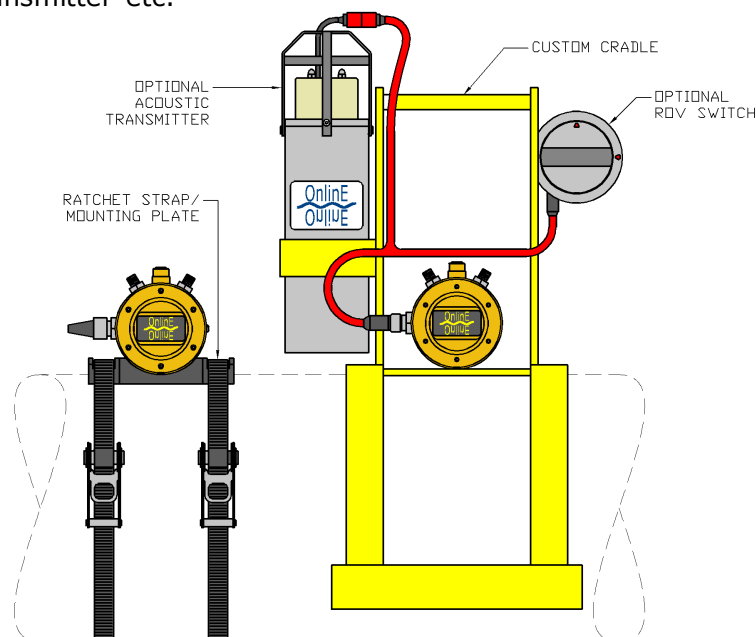

6. MAINTENANCE

Familiarise yourself with all of the rules for safe operation of this equipment as described in Section 3 RULES FOR SAFE OPERATION.

6.1. O-RING REPLACEMENT

The unit uses the following O-rings:

1x 50-008 groove in piston bleedscrew O-ring.

2x 50-243 groove in piston endcap O-rings with 2x 250-243 PTFE Back Up Rings.

1x 50-236 groove in flange window O-ring / 1x 50-237 groove in piston window O-ring.

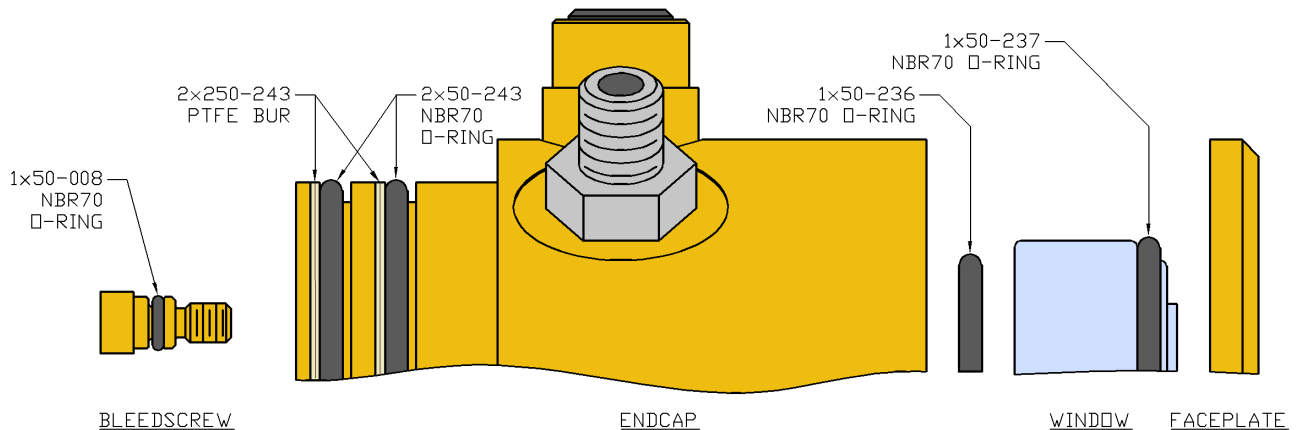

6.2. SUBSEA CABLES / CONNECTORS

Subsea connectors require regular cleaning and lubrication to ensure that contacts are clean, electrically isolated from each other and to prevent water intrusion when submerged. Before every deployment all subsea connectors and cables should be visually inspected for any visible signs of cable sheath damage, crush damage, bending damage, poorly mated or misaligned connectors etc. Seal all unused connectors with appropriate blanking caps or plugs to prevent water ingress and corrosion. Every time a connector is unmated and at least every 6 months all connectors should be inspected as follows:

1. Unmate the connector without pulling on the cable and with no rocking or twisting motions.
2. Inspect both mating halves of the connector. Check that all connector contacts are free of any accumulation of chemical deposits, saltwater, sand, mud or other debris and that all contacts are undamaged and aligned properly.
3. Accumulation of debris or corrosion should first be removed with fresh water and a brush where required, then cleaned with a suitable contact cleaner and lubricant. Do not use chemicals which could damage the connector rubber such as WD40. Any O-rings must be inspected and if marked or damaged they must be replaced.
4. When mating connectors, lubricate the connector interfaces with Molykote 111 compound (or Silicone grease) sparingly. The two halves should be pushed squarely together with no rocking or twisting motions. If the connectors have to be forced together then something is probably wrong. Do not use the locking sleeve to pull or force the connectors together. Do not over tighten the locking sleeve as this can deform the contact alignment. Locking sleeves should be tightened firmly by hand only, when the connector is subsea the water pressure will hold the connections tightly together.

6.3. ROUTINE MAINTENANCE AND STORAGE

All Online Electronics Ltd products are designed to require minimum maintenance. The housing should be cleaned using fresh water and cleaning agents as necessary. Do not use chemicals which could be damaging to the housing, the nitrile rubber O-rings, the acrylic window, or any connectors.

The unit contains a coin cell (BR2032) used to permanently power the Real Time Clock circuitry which stores the date and time as well as other system variables such as LOW POWER mode while the unit is turned OFF. This battery should be replaced every 5 years at Online Electronics Ltd premises.

If the unit is to be placed in storage for a long period of time ensure the unit has been cleaned and disconnect the main battery.

7. DISPOSAL OF UNIT

Online Electronics Ltd takes its responsibilities under the WEEE Regulations extremely seriously and has taken steps to be compliant in line with our corporate and social responsibilities. In the UK, OEL has joined a registered compliance scheme WeeeCare (registration number **WEE/MP3538PZ/SCH**).

Electrical and electronic equipment should never be disposed of with general waste but must be separately collected for the proper treatment and recovery.

The crossed out bin symbol, placed on the product, reminds you of the need to dispose of it correctly at the end of its life.

When buying a new product you will have the possibility to return, free of charge, another end of life product of equivalent type that has fulfilled the same functions as the supplied equipment. These items may be deposited at:

Online Electronics Ltd
Online House
Woodburn Road
Blackburn Business Park
Blackburn
Aberdeen
AB21 0PS
UK

Alternatively, to arrange a collection of any waste electrical equipment, obligated to OEL please telephone WeeeCare on **0844 800 2004**.

8. WARRANTY

Online products are guaranteed for one year from the date of purchase. Goods should be returned transportation prepaid to Online Electronics Limited.

There is no charge for parts or labour should any product require repair due to a manufacturing deficiency during the guarantee period.

In the event of a manufacturing deficiency the inward transportation costs will be repaid to the client.